

FIORINO



PROFESSIONAL



URBAN

WORKER

THE VAN MADE
FOR THE CITY.

FIORINO is compact, agile and able to get anywhere, starting today it's even more special and representative of a category that it has proudly **PIONEERED**.

Combines a commercial vehicle soul with a car look, together with new features to top its category for **PERFORMANCE, COMFORT** and **FUNCTIONALITY, LOAD CAPACITY** and **REDUCED RUNNING COSTS**.

Perfect in urban missions, nimble in traffic, easy to drive and park, the ideal vehicle for door to door deliveries. **CARGO VAN** to transport all types of goods and **COMBI** to transport 4 or 5 people and luggage. Whatever your road may be, **FIORINO** is ready to follow it.





URBAN

EXTERIOR

**GOOD LOOKS
RUN IN THE FAMILY.**

Family is important. The **EXTERIOR** of **FIORINO** has been redesigned with explicit references to the rest of the Fiat Professional range design, yet maintaining the model's character with a **MODERN** and **DYNAMIC STYLE**. A front with **HIGH PROJECTORS** for great visibility and protection from crashes and a **NEW BUMPER AND GRILLE** that highlights the car-like style. **FIORINO** proudly wears the **FIAT PROFESSIONAL BADGE** that emphasizes the strong brand identity and dedication to the light commercial vehicles range.





URBAN

INTERIOR

ENTER THE UNLIMITED
COMFORT ZONE.

With **FIORINO** you can relax while you are working, thanks to its **ERGONOMIC AND COMFORTABLE INTERIORS**. Now enriched by new features that make the cab functional like an actual travelling office: **STEERING WHEEL WITH RADIO COMMANDS** (also available in techno leather), **INSTRUMENT CLUSTER** permanently backlight for greater visibility, **5V USB SOCKET** and **GLOVE COMPARTMENT** design. Several as well as versatile **STORAGE COMPARTMENTS** and side panels to contain all your objects. Practical **DOCUMENT HOLDER**, passenger seat that can be folded down and be used as a table and front/rear doors closure separately to guarantee greater safety in loading/unloading operations.



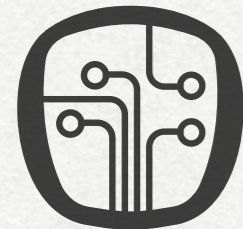

URBAN TECHNOLOGY

STAY CONNECTED AT ALL TIMES.

While you drive your business never stops. **FIORINO** offers a complete new infotainment system with the new **7" TOUCHSCREEN RADIO** that includes **BLUETOOTH**, audio streaming, USB, DAB, **APPLE CARPLAY SUPPORT AND ANDROID AUTO™**. This radio can also be upgraded with **NAVIGATION SYSTEM** for you to never get lost. Everything perfectly integrated in the dashboard giving you total control to make your phone calls without taking the hands off the wheel. Also available **RADIO CD MP3** and a **RADIO DAB PREDISPOSITION**. All the technology you need at your fingertips.



Touchscreen 5"
Bluetooth® Radio



MP3 Radio



Touchscreen 7"
Bluetooth® Radio

MOPAR® CONNECT

Thanks to MOPAR® Connect technology, the driver will be always connected with his Fiorino: remote assistance and control service guarantee the opportunity to drive safely, in complete freedom and with easier vehicle care.



MY:ASSISTANT

**YOUR SAFETY AND YOUR SECURITY
ARE ALWAYS OUR PRIORITY**

CRASH ASSISTANCE

In case of crash, the system instantly responds contacting a Mopar agent to provide you full assistance.

ROADSIDE ASSISTANCE

In case of breakdown, get immediately in touch with a Mopar agent, who can check the situation from remote and provide assistance to the location reported by your Fiorino GPS.

THEFT ASSISTANCE

Get an alert when your vehicle is moving in a suspicious way and get assistance for tracking it and recovery.



MY:REMOTECONTROL

**LET YOUR SMARTPHONE BECOME AN
INTERACTIVE KEY TO REMOTELY CONTROL
YOUR FIORINO WHEREVER YOU ARE AND
WHENEVER YOU NEED**

FIND CAR

Find easily where your vehicle is parked. The system will pinpoint the location on a map and provide you the fastest way to reach it.

LOCK DOORS

Lock or unlock the vehicle from remote.

SET NOTIFICATION

Geo Alert

Be alerted whenever the vehicle gets in or out a defined geographical area

Speed alert

Be notified if your vehicle goes beyond a defined speed limit.



MY:CAR

**THE PERSONAL TRAINER TO KEEP YOUR
FIORINO ALWAYS FIT**

LIVE STATUS

Keep the vehicle status always under control. Main features, such as remaining fuel, battery level, tire pressure, current mileage and doors status can be always checked in real time anywhere.



URBAN

POWER

**A SELECTION OF
ENGINES TO GET
YOU STARTED.**

Agility is key in the city. **FIORINO** comes with a **FULL RANGE OF EURO 6d-TEMP**, the most complete offer in the segment: diesel, petrol and methane engine.

The **DIESEL MULTIJET₂** engine is marked by great driving satisfaction, excellent performance, low running costs and environmental sustainability. Saving is also the key. **FIORINO** provides the **ECOJET*** version that offers a considerable reduction in terms of fuel consumption and emissions level, with a saving up to 11%.



*Diesel ECOJET: Start&Stop system, high efficiency alternator management and variable displacement oil pump.

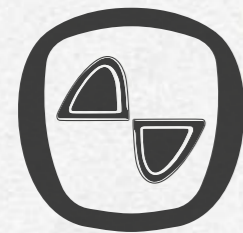

URBAN ENGINES

**DRIVE WITH
A NATURAL
ADVANTAGE.**

The **CNG METHANE ENGINE** makes **FIORINO NATURAL POWER** an **EXCLUSIVE IN ITS CATEGORY**. A real bi-fuel solution to cut running costs and fuel consumption. Includes a 77 L methane cylinder tanks capacity (around 13 Kg) together with a 45 L petrol tank capacity that guarantees a total range more than 900 Km. Efficient loading area volume thanks to the underfloor tanks. The methane fuel means, not only, **ECO-FRIENDLY**, but also means, free access to the **URBAN RESTRICTED TRAFFIC AREAS***, so you can go to the city center and get your work done.

* excluding traffic restrictions not due to environmental reasons or local specific rules.



**natural
power**

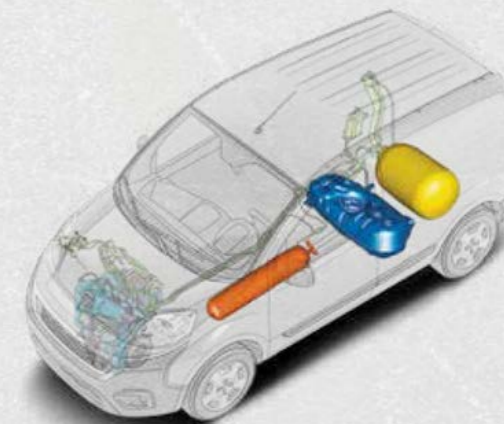



URBAN
CAPACITY
PLENTY OF ROOM
FOR VERSATILITY.



As everyone knows, it's important to draw attention around town. Just like **FIORINO** does with its unmistakable car-like style and new anterior looks, now even more appealing. But for those who have work to do, appearance isn't everything. **FIORINO** combines its unique design with a load compartment **VOLUME UP TO 2.8 M³** and **EASY ACCESS** thanks to the **WIDE SLIDING SIDE DOOR** with **ERGONOMIC VERTICAL**

HANDLES, to help you take charge of all your tasks. But the advantages do not end there, **FIORINO** has everything it takes to do a great job: **CAPACITY UP TO 610 KG**, **A REGULAR SQUARE SHAPE** and **180° REAR DOOR OPENING** which grant easy and convenient access to the loading bay and a **LOAD THRESHOLD HEIGHT OF JUST 527 MM**. Finally a **9.95 M TURNING CIRCLE** to provide you great handling.





URBAN

CAPACITY

PLENTY OF ROOM
FOR VERSATILITY.



644

1041

570

1205

1473

1046

1523/2491*

527

* with passenger seat folded

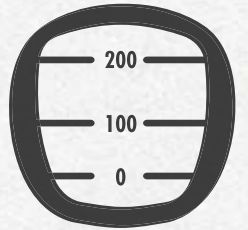

URBAN
CAPACITY

**PLENTY OF ROOM
FOR VERSATILITY.**

The versatility of the **PIVOTING SPLIT PARTITION** combined with a front passenger seat folded down to the floor completely flat, enables a **LOAD COMPARTMENT LENGTH** increase by nearly one meter and volume increase of 0.3 M³. This allows you to carry long objects with a total load compartment length of nearly **2.5 M** and **2.8 M³ VOLUME**.



The sliding side door blends perfectly into the side panel and the vertical exterior handle offers an excellent grip and can be opened with both hands.

Load compartment ceiling light and removable torch.

Load compartment 12V power outlet.





— URBAN —

ADVENTURE

**OFF THE BEATEN
PATH WITHOUT
TAKING A BEATING.**

FIORINO ADVENTURE is the ideal vehicle for who needs to tackle rugged terrain, drive in mountain or simply wants to take on winter weather without troubles. **ADVENTURE** is a special version matched with an electronic differential lock **TRACTION+**, a device that gives you the extra grip to overcome rough situations on the country side, like mud and snow. This system is activated through a button located on the dashboard, in acceleration phase under 50 Km/H. Also includes higher suspension and specific 15" tyres M+S, under-engine protection, front bumper with skid plate and higher side protections.





URBAN

COMBI

**MOVE MORE THAN
JUST PEOPLE.**

FIORINO COMBI is the transport versatility at your business service: accommodates **UP TO 5 PEOPLE** and plenty of space for goods and luggage, with a **LOAD CAPACITY OF 140 KG**. This makes it the ideal vehicle for carrying your work team and their tools in comfort and safety. Also available in **4 SEATS** with a load capacity of **265 KG**. Through the **WIDE SIDE SLIDING DOOR** the passengers can access the comfy rear seats up to 3 places (with Isofix attachment points for child transport). Also available an additional side sliding door to facilitate the access of all passengers. The functionality is guaranteed by the totally foldable and removable rear seats to open space for an authentic van loading area with a volume up to 2.5 M³.





URBAN

SAFETY

IT KEEPS YOU SAFE.

When your business involves you being on the road every day, safety is paramount.

FIORINO offers all the safety equipment and driving aids such as **ABS** with electronic brake force distribution **EBD**, **ESC** complete with **ASR** (Anti Slip Regulation) and **HBA** (Hydraulic Brake Assist).

HILL HOLDER for those tricky hill-starts and **PARKING SENSORS**. Front **AIRBAGS** and front side airbags, which protect both head and chest. **CRUISE CONTROL*** helps you maintain total control while driving especially in the highway.

** Only on diesel*

TRACTION+



Is an aid for driving and setting off in poor grip conditions (snow, ice, mud, etc.) which allows the drive force to be distributed over the same axle when both wheels are slipping. It acts by braking the wheels with poor grip (or those slipping more than the others), thereby transferring the drive force to those which have more grip on the ground.

CRUISE CONTROL



It allows you to drive on long and straight roads with few driving changes (motorways) at a pre-set speed without having to press the accelerator pedal.



ESC

The Electronic Stability Control is a system that controls vehicle stability in the event of tyre grip loss, helping to maintain directional control.

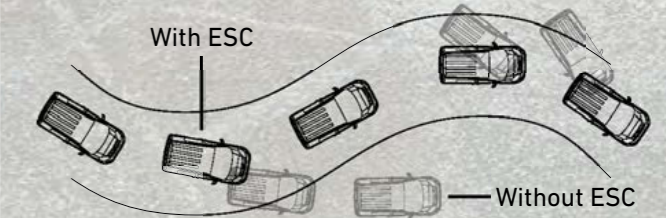

HILL HOLDER

Integrated in the ESC system, it automatically activates in uphill/downhill with engine running and blocks the vehicle for few seconds without you having to press the brake pedal.

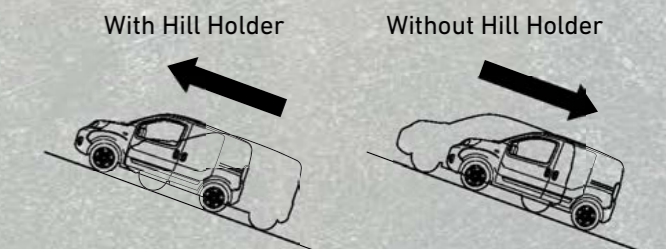



URBAN CUSTOMIZATION

**PERSONALITY ALWAYS
MAKES A DIFFERENCE.
AT WORK TOO.**

FIORINO is complete with a full range of accessories, all top quality, created by **MOPAR®: THE REFERENCE BRAND FOR SERVICES, CUSTOMER CARE, GENUINE PARTS AND ACCESSORIES** of Fiat Chrysler Automobiles.



PROFESSIONAL



MOPAR®



One-piece steel roof racks can be used to carry bulky packages and materials.

Set of 3 steel bars with a capacity of 90 kg.



Tow hook available in 3 configurations: two fixed and one removable.



Set of two nets on the rear doors, handy for holding small objects in place.





URBAN

STYLE

**DRESSCODE:
CHAMELEON.**

Every work has its own requirements. And **FIORINO** is ready to meet them all. Choose between **10 BODY COLOURS** and **3 SEAT FABRICS**, all designed to enhance passenger comfort and please even the most tireless and demanding worker like you. Decide which version is best, which type of body you like the most and go! Your projects can't wait.

PASTEL BODY COLOURS



249 White

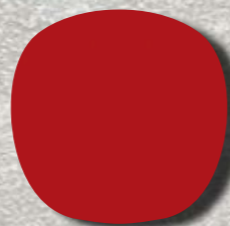

168 Red

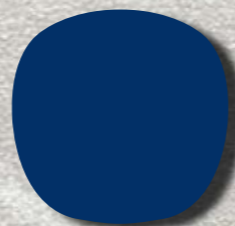

479 Blue



551 Orange

METALLIC BODY COLOURS



293 Dark Red



333 Light Blue



515 Dark Blue

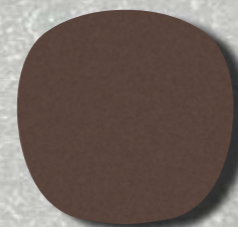

444 Bronze



612 Light Gray



632 Black

FIORINO CARGO - COMBI



FABRICS



cod. 094

FIORINO CARGO - COMBI SX



FABRICS



cod. 323



cod. 319

FIORINO CARGO - COMBI ADVENTURE



FABRICS



cod. 323



cod. 319

HUB CAPS AND RIMS



15" 15" 15" 15" Trekking

HUB CAPS AND RIMS



15" 15" 15" Trekking

HUB CAPS AND RIMS



15" 15" 15" Trekking

TECHNICAL SPECIFICATIONS

Engine	1.4 8v Fire		1.4 Fire Natural Power		1.3 16v MultiJet, 80 HP			1.3 16v MultiJet, 95 HP		
	Van	Combi M1	Van	Combi M1	Van	Combi N1	Combi M1	Van	Combi N1	Combi M1
No. of cylinders, layout	4, in line		4, in line		4, in line			4, in line		
Displacement (cm³)	1368		1368		1248			1248		
Emission level	Euro 6d-TEMP		Euro 6d-TEMP		Euro 6d-TEMP with SCRF ECOJET: with Start&Stop - ECOpack			Euro 6d-TEMP with SCRF ECOJET: with Start&Stop - ECOpack		
Compression ratio	11.1 : 1		11.1 : 1		16.8 : 1			16.8 : 1		
Max power: kw (HP) at rpm	57 (77) 6000		51 (70) 6000 * - 57 (77) 6000		59 (80) 3750			70 (95) 3750		
Max torque: Nm at rpm	115 at 3000		104 at 3000 * - 115 at 3000		200 at 1500			200 at 1500		
Fuel system	Multipoint electronic injection phased sequential		Multipoint electronic injection phased sequential, specific for methane		MultiJet direct injection electronic Common Rail with variable geometry turbocharger and intercooler			MultiJet direct injection electronic Common Rail with variable geometry turbocharger and intercooler		
Transmission	front		front		front			front		
Drive	front		front		front			front		
Wheels										
Tyres	185 / 65 R 15	185 / 65 R 15	185 / 65 R 15		185 / 65 R 15 185 / 65 R 15 Q (M+S)	185 / 65 R 15 185 / 65 R 15 Q (M+S)		185 / 65 R 15 - 185 / 65 R 15 Q (M+S)		
Suspensions										
Front	independent McPherson		independent McPherson		independent McPherson			independent McPherson		
Rear	torsion beam		torsion beam		torsion beam			torsion beam		
Capacity										
Fuel tank (l)	45		13.2 kg methane / 45 l petrol		45			45		
Urea tank (l)	-		-		11.8			11.8		
Steering										
Kerb-to-kerb turning circle (m)	9.95		9.95		9.95			9.95		
Brakes - D (disc) - T (drum)										
Front side (mm)	D 257		D 257		D 257			D 284		
Rear side (mm)	T 203		T 228		T 228			T 228		
Performance										
Top speed (km/h)	157	155	149		162	161	161	167		
Fuel consumption (l/100 km) (kg/100 km methane version) (max - min)										
Urban cycle	9.3 ^(B)	9.4 ^(B)	9.8 / 6.4 ^{▼(B)}	9.7 / 6.4 ^{▼(B)}	6.1-6.2 ^(B) ECOJET: 4.6-5.6 ^(B)	6.1 - 6.2 ^(B) ECOJET: 5.4-5.6 ^(B)	ECOJET: 5.0-5.8 ^(B)	6.1-6.2 ^(B) ECOJET: 4.6-5.6 ^(B)	6.1-6.2 ^(B) ECOJET: 5.4-5.6 ^(B)	ECOJET: 5.0-5.8 ^(B)
Extra-urban cycle	6.0 ^(B)	6.1 ^(B)	6.0 / 4.1 ^{▼(B)}	6.1 / 4.2 ^{▼(B)}	3.9-4.1 ^(B) ECOJET: 3.8-4.6 ^(B)	4.1 - 4.2 ^(B) ECOJET: 3.9-4.0 ^(B)	ECOJET: 3.9-4.5 ^(B)	3.9 - 4.1 ^(B) ECOJET: 3.8-4.6 ^(B)	4.1 - 4.2 ^(B) ECOJET: 3.9-4.0 ^(B)	ECOJET: 3.9-4.5 ^(B)
Combined cycle	7.2 ^(B)	7.3 ^(B)	7.4 / 5.0 ^{▼(B)}	7.4 / 5.0 ^{▼(B)}	4.7 - 4.8 ^(B) ECOJET: 4.4-4.8 ^(B)	4.8 - 4.9 ^(B) ECOJET: 4.5-4.6 ^(B)	ECOJET: 4.5-4.9 ^(B)	4.7 - 4.8 ^(B) ECOJET: 4.4-4.8 ^(B)	4.8 - 4.9 ^(B) ECOJET: 4.5-4.6 ^(B)	ECOJET: 4.5-4.9 ^(B)
CO ₂ emissions (max - min)	165 ^(B)	167 ^(B)	168 / 132 ^{▼(B)}	169 / 135 ^{▼(B)}	125-128 ^(B) ECOJET: 116-120 ^(B)	128 - 130 ^(B) ECOJET: 118-121 ^(B)	ECOJET: 118-123 ^(B)	125-128 ^(B) ECOJET: 116-120 ^(B)	128-130 ^(B) ECOJET: 118-121 ^(B)	ECOJET: 118-123 ^(B)

STANDARD AND OPTIONAL EQUIPMENT

	Cargo/Combi	Cargo/Combi SX	Cargo/Combi Adventure
Exterior			
Tinted windows	S	S	S
Key-lockable fuel filler cap	S	S	S
Moulding	S	S	S
Integral hub caps	878	• / S	• / S
Electrically adjustable door mirrors with demister	041	•	S
Additional sliding side door	055	•	•
Fog lights	097	•	•
Rear Window Wiper	101	•	• / S
15" alloy wheels	108	•	•
15" tyres	141	S	S
15" Winter tyres	142	•	•
15" M+S tyres		-	S
Metallic paint	210	•	•
Longitudinal bars for roof rack	357	•	•
15" alloy wheels Trekking	420	•	•
Two asymmetric glazed rear swing doors	519	• / S	• / S
Sliding side door glazed	520	• / -	• / -
Sliding side door	523	• / S	S
Side windows, fixed 2nd section	55D	• / S	• / S
Front grille Ultrashine silver	876	•	S
Mudguards	990	•	•
Interior			
Protective ladder		S / -	S / -
Load compartment mat	798	S	S
Front seat armrest*	132	•	S
Fixed metal partition	149	• / -	• / -
Fixed metal partition with central glazed window	199	• / -	• / -
Pivoting split partition	201	• / -	• / -
Lower side bulkhead insulation	552	• / -	• / -
Driver seat lumbar adjustment	40Y	•	S
Height-adjustable driver seat	450	•	S
Heated front seats	452	•	•

	Cargo/Combi	Cargo/Combi SX	Cargo/Combi Adventure
Interior			
Heated driver seat	453	•	•
Passenger seat, foldable to floor	46Q	• / -	• / -
Load compartment socket	4HG	• / -	• / -
Mixed partition: panelled at bottom / grille at top	4PB	• / -	• / -
Document holder on dashboard	4PS	•	•
Protective ladder partition for Combi (N1 homologation)	56K	- / •	- / •
TPO passenger compartment carpet	5JC	S / •	S / •
Reduced GVW 1500 kg	758	• / -	-
Floor luggage net	762	- / •	- / •
Glove compartment flap	845	•	S
Rear head restraints	182	- / •	- / •
Functional / Electrical			
Power steering		S	S
Headlight alignment corrector		S	S
12 V socket		S	S
Door lock/unlock remote control	008	•	S
Steering wheel height adjustment	011	•	S
Climate control	025	•	•
Electric front windows	028	•	S
Heated rear window	029	•	• / S
Dead Lock	064	•	•
Larger alternator (only for diesel versions)	065	• / -	• / -
Electric door lock	228	•	S
Cruise control (only for diesel versions)	416	•	•
Parking sensor	508	•	•
Removable ceiling light	58F	•	•
Start&Stop System (links pack EcoJet) (only for diesel versions)	5DE	•	•
Pack EcoJet (links Start&Stop) (only for diesel versions)	66M	•	•
5V socket with USB port	83X	•	•

STANDARD AND OPTIONAL EQUIPMENT

	Cargo/Combi	Cargo/Combi SX	Cargo/Combi Adventure
Functional / Electrical			
Smoker's kit	989	•	•
Safety			
ESC with ASR, HBA, Hill Holder		S	S
4 sensor ABS + EBD (Electronic Brake Distribution)		S	S
Driver airbag		S	S
Multi-use Fix&Go tyre repair kit		S	S
Automatic door closure at speed higher than 20 km/h	130	•	S
Passenger airbag	502	•	•
Side airbags	505	•	•
Independent load compartment opening	57E	• / -	S / -
Traction+ (includes ESC)		-	S
Normal size steel spare wheel	980	•	•
Audio / Telematics			
Provision for sound system with speakers and aerial	072	•	S
Steering wheel radio controls	245	•	•
Touchscreen 5" Bluetooth* Radio [▼]	414	•	•
Touchscreen 5" Bluetooth* Radio NAV [▼]	4CU	•	•
Touchscreen 7" Bluetooth* Radio [▼]	1NJ	•	•
Touchscreen 7" Bluetooth* Radio DAB [▼]	1RB	•	•
Touchscreen 7" Bluetooth* Radio DAB & NAV [▼]	1RC	•	•
Techno leather steering wheel with radio controls	5KV	•	•
MP3 radio	717	•	•
Provision for DAB Radio	6QD	•	•

* not available with partition Opt. 201 ▼ links steering wheel controls Opt. 245

S = standard • = optional - = not available

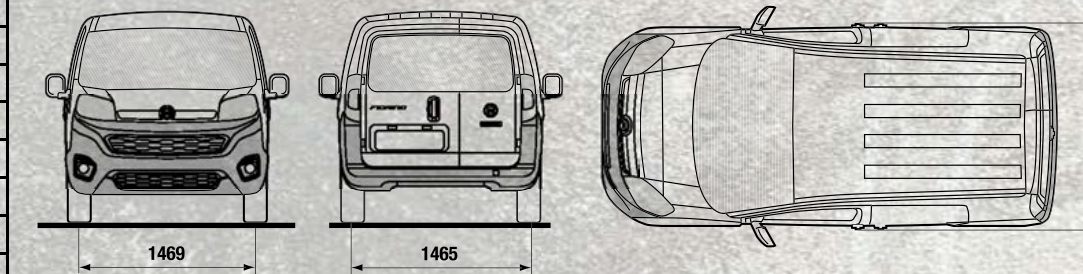
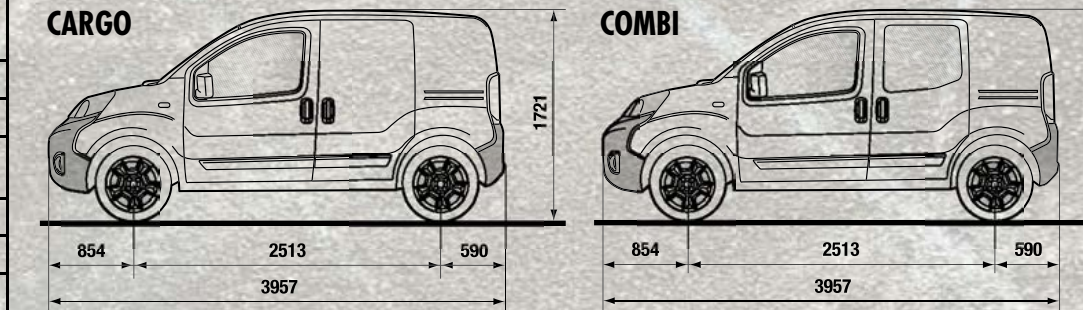

TECHNICAL SPECIFICATIONS

Dimensions	1.4 8v Fire		1.4 Fire Natural Power		1.3 16v MultiJet, 80 HP		1.3 16v MultiJet, 95 HP	
	Van	Combi	Van	Combi	Van	Combi	Van	Combi
Length (mm)	3957	3957	3957	3957	3957	3957	3957	3957
Width (mm)	1716	1716	1716	1716	1716	1716	1716	1716
Height (mm)	1721	1721	1721	1721	1721	1721	1721	1721
Wheelbase (mm)	2513	2513	2513	2513	2513	2513	2513	2513
Front overhang (mm)	854	854	854	854	854	854	854	854
Rear overhang (mm)	590	590	590	590	590	590	590	590
Front track (mm)	1469	1469	1469	1469	1469	1469	1469	1469
Rear track (mm)	1465	1465	1465	1465	1465	1465	1465	1465
<i>Trunk</i>								
Volume (m³)	–	0.36-2.5	–	0.27-2.1	–	0.36-2.5	–	0.36-2.5
<i>Load compartment</i>								
Length (mm)	1523-2491 [■]	–	1452	–	1523-2491 [■]	–	1523-2491 [■]	–
Width (mm)	1473	–	1473	–	1473	–	1473	–
Width between wheel arches (mm)	1046	–	1046	–	1046	–	1046	–
Height (mm)	1205	–	1070	–	1205	–	1205	–
Load threshold (mm)	527	–	677	–	527	–	527	–
Volume (m³)	2.5-2.8 [■]	–	2.1-2.4 [■]	–	2.5-2.8 [■]	–	2.5-2.8 [■]	–
<i>Side Sliding door</i>								
Width (mm)	min 570 / max 644	min 570 / max 644	min 570 / max 644	min 570 / max 644	min 570 / max 644	min 570 / max 644	min 570 / max 644	min 570 / max 644
Height (mm)	1041	1041	1041	1041	1041	1041	1041	1041
<i>Rear door with two wings</i>								
Width (mm)	min 1056 / max 1140	min 1056 / max 1140	min 1056 / max 1140	min 1056 / max 1140	min 1056 / max 1140	min 1056 / max 1140	min 1056 / max 1140	min 1056 / max 1140
Height (mm)	1040/1060	1040/1060	1040/1060	1040/1060	1040/1060	1040/1060	1040/1060	1040/1060
<i>Weights</i>								
Unladen weight (kg)	1070	1165	1180	1270	1130	1215	1130	1215
GVW (kg)	1680	1680	1680	1750	1740-1790	1780 ▲ - 1730	1740-1790	1780 ▲ - 1730
Payload including driver (kg)	610	5 seats + 140 kg	500	5 seats + 105 kg	610-660	4 seats + 265 kg ▲ 5 seats + 140 kg	610-660	4 seats + 265 kg ▲ 5 seats + 140 kg
Payload excluding driver (kg)	535	–	425	–	535-585	–	535-585	–

▼ Methane engine ■ with passenger seat folded ▲ N1 homologation

Fiat Professional recommends the original engine oils



The specification (B) indicates the value of CO₂ and fuel consumption determined on the basis of the measurement/correlation method referring to the NEDC cycles as per Regulation (EU) 2017/1152-1153. The indicated value of CO₂ and fuel consumption refers to the versions of the vehicle with the highest and the lowest values. Those values may change with the subsequent configuration depending on equipment selected and/or size of tires selected. The indicated values of CO₂ and fuel consumption are not definitive and may evolve as a result of changes in the production cycle; more up-to-date values will be available at the selected official dealer of the FCA network. In any case, the official values of CO₂ and fuel consumption of the vehicle purchased by the customer will be provided with the documents accompanying the vehicle.



PROFESSIONAL

URBAN

CARE

ALL SUPPORT TO YOUR NEEDS.

FIORINO is not just a work vehicle. It is also the vehicle that connects you to the large **FIAT PROFESSIONAL** network that is widespread, efficient and always willing to meet your needs and requirements. In short, choosing **FIORINO** also means climbing on board a world of full-range services. Because Fiat Professional knows that work never stops.

VEHICLE WARRANTY

Fiat Professional is a trading name of Fiat Chrysler Automobiles, guarantees your vehicle against manufacturing faults for a period of 24 months from the date of first registration and without mileage limits. Under this Warranty, the Dealer must repair components which are defective due to a manufacturing defect by replacing them with genuine Fiat Professional spare parts or reconditioned Fiat Professional parts free of charge.

Operations under Warranty carried out by a Fiat Professional Dealership include:

- repair or replacement of the faulty component
 - labour needed for the replacement or repair
 - supply of consumable materials needed to carry out the repair under Warranty.
- You have the benefit of roadside assistance for the duration of the Warranty.

Paintwork Warranty

The vehicle is warranted against manufacturing defects of the paintwork for a period of 36 months from the date of first registration. The Warranty provides for the total or partial repainting of the vehicle to the extent necessary and elimination of any ascertained fault according to the Manufacturer's standard conditions.

Perforating Corrosion Warranty

The structural elements of the bodywork are warranted against perforations caused by rust, when it occurs from the inside out. The Warranty provides for the repair and/or replacement of any original, bodywork structural element damaged by perforating rust and is valid for 8 years from date of first registration. The Warranty does not cover defects caused, wholly or partly, or aggravated by the failure to carry out scheduled servicing required by the Manufacturer at the frequency indicated in the Owner Handbook. Any faults found and not covered by Warranty will be recorded on the body inspection certificates when Schedule Servicing coupons are carried out. Please check the specific conditions of the coverages in your warranty booklet.

CUSTOMER CARE CIAO FIAT

You can contact Fiat Professional by calling the dedicated Toll Free Number 0080034280000* reachable from most European countries. We are at your disposal to provide Road Assistance services, active 365 days a year, 24 hours a day. By contacting Fiat Professional Customer Care you can also request info on our models, services, dealer network and, lastly, book a test drive on a vehicle of your choice. Fiat is at your disposal to satisfy every necessity or request linked to the use of your vehicle or our assistance services.

*Remember to check the call costs with your phone provider when calling from abroad or mobile phones.



SPECIAL SALES PROGRAMMES

Customised mobility solutions? Autonomy is aimed at people with reduced motor abilities and proposes specific trim levels for passenger transport vehicles, roadside assistance and financial services. It also offers comprehensive assistance in obtaining a special driving licence from Mobility Centres. Call freephone number 800-838333 to obtain full and complete information based on your needs.



MY FIAT PROFESSIONAL

Take care of your vehicle in one click! Register now on my Fiat Professional and discover the services to support your needs. Go to myfiatprofessional.com

my Fiat Professional

FINANCE PACKAGES AND INSURANCE SERVICES*

Find out how to get hold of your Fiat Professional Vehicles with the innovative financing solutions of FCA BANK. Whether you are a retail customer, self-employed or run your own business, FCA BANK offers you the best and most flexible financial tools to facilitate your forthcoming purchase of a Fiat Professional Vehicles so that you can drive it away. With FCA BANK you can combine your finance loan with high value-added insurance services tailored to meet your every requirement.

However you choose to travel, FCA BANK can meet your needs with financial and leasing packages combined with exclusive services.

Instalment plans Classic loan plan that allows you to spread the payment of all or part of your new vehicle, choosing the contract duration and down payment.

Leasing If you are a professional, self-employed or run your own business, this solution offers you the option of using your vehicle without tying up your capital. You have a choice of contract duration and down payments, plus a flexible final redemption value.

Moreover FCA Bank proposes long-term rental as ideal solution for companies, professionals and private individuals who want to benefit from a new vehicle without the burden of ownership and the duties that this involves. In addition to financing plans, FCA BANK offers a wide range of services designed to protect you from unexpected events: **indelible marking** on key vehicle components as a maximum deterrent against theft, the **special Fire&Theft, Collision** (protection against collisions with other vehicles), **Kasko** (fully comprehensive insurance) and **Prestito Protetto** (loan protection (e.g. instalment repayment if you lose your job) policies and various types of **Mopar® Vehicle Protection Plans** to maintain your vehicle in tip-top conditions

* For more information about the company, visit HYPERLINK <http://www.fcabankgroup.com> www.fcabankgroup.com



MOPAR® VEHICLE PROTECTION

Mopar® Vehicle Protection (MVP) offer a series of service contracts that are designed to give all our customers the pleasure of driving their vehicle without any hitch's and concerns. Our product portfolio consists of a wide range of extended warranty and maintenance plans, with a flexible series of coverage tiers, built to accommodate your driving needs. All endorsed by FIAT PROFESSIONAL.

Subscribe to one of the MVP service contracts directly when purchasing a Fiorino and include (if desired) in the FCA Bank financial offer (on selected markets) or within subscription terms of each product.

MVP guarantee's that all service operations are performed with genuine parts by highly qualified and specialized technicians in authorized FIAT PROFESSIONAL repair facilities, all over Europe.

Choose the Service Contract that suits your driving habits best.

MAXIMUM CARE: 100% PEACE OF MIND, WHEREVER YOUR JOURNEY TAKES YOU

Extend the vehicle warranty, beyond the factory warranty, for up to a maximum of +3 years with the protection plan built to cover all mechanical and electrical components. Designed to supplement the standard manufacturer warranty and ensure that you get the best value for money. Subscribe to a MAXIMUM CARE program within 24 months after vehicle registration.

EASY CARE: FIX THE PRICE OF YOUR REGULAR SERVICING

A service plan designed to be a simple way to budget for your Fiorino's servicing requirements, ensuring your vehicle never misses a vital service interval and guarantee you get the maximum life out of your vehicle.

Subscribe to an Easy Care program any time before the first service.





NEW

RANGE

FIAT PROFESSIONAL

A PRO LIKE YOU.

Recognizing a real pro is simple: just look at the equipment he has chosen for himself. Real pros work with pro tools only. That's why **FIAT PROFESSIONAL** is the best partner you could have, whatever your needs are. Its full **RANGE IS THE FIRST AND ONLY ONE BRANDED "PROFESSIONAL"** and it has been especially designed for specific purposes: yours.



DOBLÒ

You couldn't ask for a better way to work. You couldn't ask for a better business card. Simply unique. Just like your job.



FIORINO

The vehicle that invented the category. Unequalled in agility and capability. Cities love it. And so do the pros.



TALENTO

Agile, capable and ingenious. It's got the unique talent of transforming problems into solutions and challenges into opportunities. Day by day.



DUCATO

It's the undisputed leader in the world of work: the ground it's based upon. Strong, versatile and indispensable to everyone.





A PRO LIKE YOU



www.fiatprofessional.com